

CRYSTORAMA

LIGHTING THE WAY FOR SIXTY YEARS

ASSEMBLY INSTRUCTION MODEL #5162-EB-CL-MWP

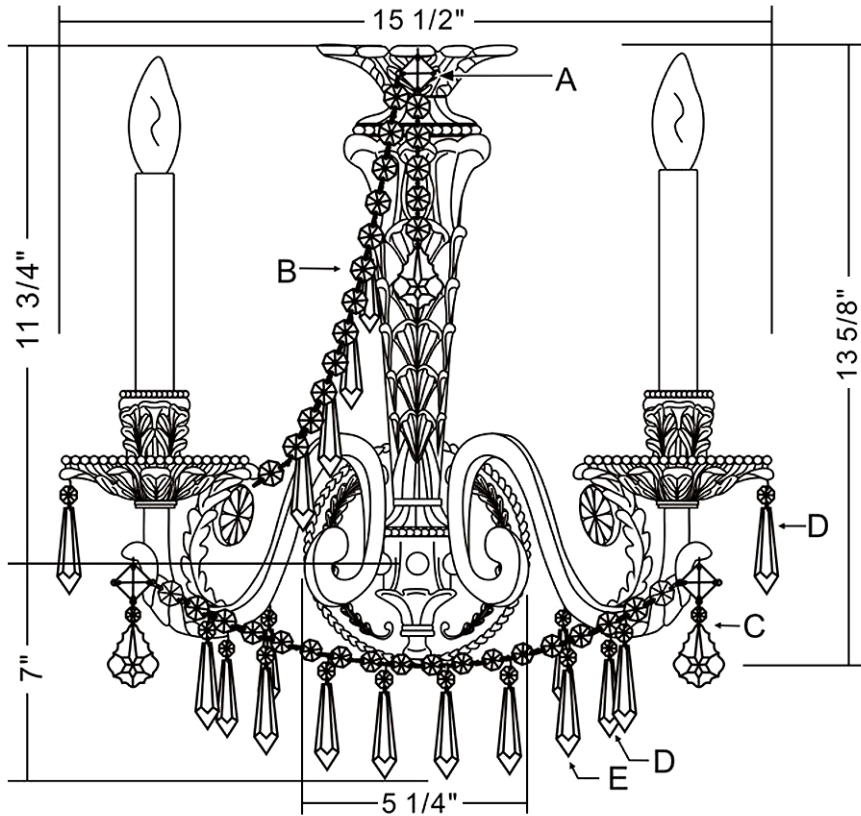

WARNING:



Electrical Danger

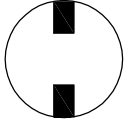

Turn Power Off

All electrical components must be installed by a licensed electrician in accordance with the National Electric Code and the appropriate local electrical codes.

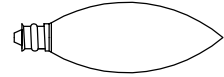

You will need 2 - Candelabra Bulb
40 Watts Recommended 60 Watts Max.
USE LED BULBS FOR EXTENDED USE

How to Install

1. Attach mounting plate to the outlet box using box screws.
2. Connect the fixture wires to the supply wires.
3. Mount the fixture to the outlet box with finial.
4. Install the bulb (Not included) in accordance with the fixture's specifications. (DO NOT EXCEED THE MAXIMUM WATTAGE RATING!)
5. Hook crystal on the body as shown.

Crystal Sets

- A. 1 Set. 18mm+14mm*5+76mm
- B. 2 Set. 14mm*13+38mm*4
- C. 2 Set. 18mm+14mm+76mm
- D. 20 Set. 14mm+38mm
- E. 1 Set. 14mm*18+(14mm+38mm)*8

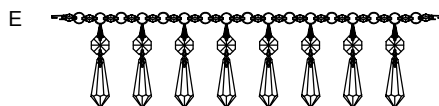
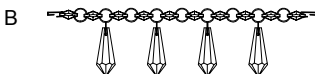
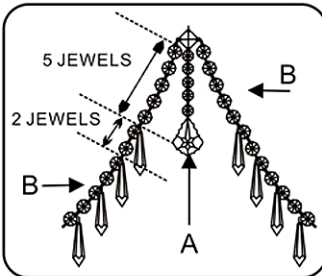
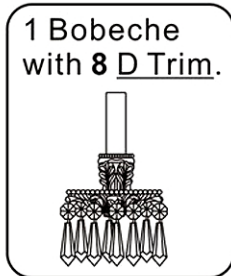
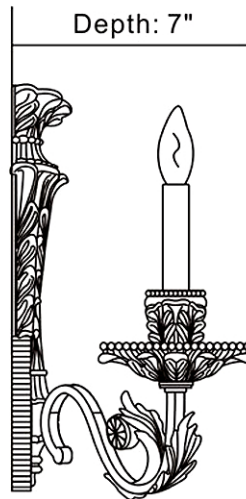
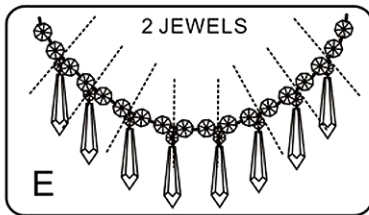

WARNING: This product can expose you to Lead, which is known to the State of California to cause cancer and/or birth defects or reproductive harm. For more information go to www.P65Warnings.ca.gov

CRYSTORAMA

LIGHTING THE WAY FOR SIXTY YEARS

PART NUMBER MODEL #5162-EB-CL-MWP

Part Number

Part Numbers

A. Mounting Hardware

(3) - Wire connector

(1) - Mounting Plate

(2) - Box Screws

(1) - Grounding Screw

B. (1) - Ball Nut;

XVE5162EBBANUT

C. (2) - Candle Sleeve; Ø22X110mm;

XVE5168EBCDL4.3IN

